

**MIDDLE  
ATLANTIC**  
A brand of **legrand**



**NEXSYS**<sup>TM</sup>

---

## **Rackmount PDU**

### User Manual

100-00060Rev A





©2024 | [Legrand AV, Inc.](#) All rights reserved.

Information in this document is subject to change without notice. The AV equipment described in this document is furnished under a license agreement or nondisclosure agreement. The equipment may be used or copied only in accordance with the terms of those agreements. No part of this publication may be reproduced, stored in a retrieval system, or transmitted in any form or any means electronic or mechanical, including photocopying and recording for any purpose other than the purchaser's personal use without the written permission of Legrand AV.

---

Middle Atlantic is a brand of Legrand AV.

[www.legrandav.com](http://www.legrandav.com) | Phone: (866) 977-3901 | Fax: (877) 894-6918 | Email: [av.middleatlantic.techsupport@legrand.com](mailto:av.middleatlantic.techsupport@legrand.com)

Visit us at [www.legrandav.com](http://www.legrandav.com) for firmware updates, specifications, drawings, manuals, technical support information, and more.

Middle Atlantic is a registered trademark of Legrand AV, Inc.

Legrand AV is an ISO 9001 and ISO 14001 Registered Company.

All other brand names or marks are used for identification purposes and are trademarks of their respective owners.

All patents are protected under existing designations. Other patents pending.

Legrand AV Inc. Brands: Chief | Da-Lite | Middle Atlantic | Projecta | Sanus | Vaddio

# Contents







IMPORTANT SAFETY INSTRUCTIONS - EN .....	iv
INSTRUCTIONS IMPORTANTES SUR LA SÉCURITÉ - FR .....	vi
Regulatory Compliance .....	ix
Conformité Réglementaire .....	x
Industry Canada (IC) .....	x
Industrie Canada (IC) .....	x
Waste Electrical and Electronic Equipment (WEEE) Directive .....	xi
Directive sur les déchets d'équipements électriques et électroniques (WEEE) .....	xi
Understanding General Symbols and Terms .....	xii
Supplied Components and Hardware .....	xiii
Required Tools .....	xiii
Introduction .....	14
Mounting Your NEXSYS Series Rackmount PDU .....	14
Feature Set .....	16
LED Protection Indicators .....	18
Surge Protection .....	18
Voltage Protection .....	18
Specifications .....	19
Specifications for MOV Surge Models .....	19
Summary .....	19
Hardware Features .....	19
Physical .....	21
Specifications for Series Surge Protection Models .....	21
Summary .....	21
Hardware Features .....	22
Physical .....	23
Warranty .....	24

# IMPORTANT SAFETY INSTRUCTIONS - EN

SAVE THESE INSTRUCTIONS - This manual contains important instructions that should be followed during installation and maintenance of the product.

- Only use attachments and accessories specified by the manufacturer.
- Read all instructions before using the product.

## Understanding Safety Symbols

	<p><b>DANGER HAZARDOUS VOLTAGE</b></p>	<p>The lightning flash with the arrowhead symbol, within an equilateral triangle is intended to alert the user to the presence of uninsulated dangerous voltage within the product’s enclosure that may be of sufficient magnitude to constitute a risk of electric shock to persons.</p>
	<p><b>WARNING</b></p>	<p>A warning alerts you to a situation that could result in serious personal injury or death.</p>
	<p><b>CAUTION</b></p>	<p>A caution alerts you to a situation that may result in minor personal injury or damage to the product and/or property.</p>
	<p><b>NOTE</b></p>	<p>A note is used to highlight procedures pertaining to the installation, operation, or maintenance of the product.</p>
	<p><b>REMINDER</b></p>	<p>A reminder marks information which may be of importance to you for recalling in context and/or later use.</p>
	<p><b>TIP</b></p>	<p>A tip helps users apply techniques and procedures for their specific needs. The information suggests alternative methods that may not be obvious and help users understand the benefits and capabilities of the product. A tip is not essential to the basic understanding of the material.</p>

	<p><b>DANGER HAZARDOUS VOLTAGE</b></p>	<p>To reduce the risk of electrical shock, always unplug this device from the electrical outlet before cleaning.</p>
---	--	--

	<p><b>WARNING</b></p>	<p>Failure to read, understand and follow the following information can result in serious personal injury, damage to the equipment or voiding of the warranty. It is the responsibility of the Installer/User to ensure that this product is loaded according to specifications.</p>
---	-----------------------	--

**WARNING**

Risk of Electric Shock: Connect the device to a properly grounded outlet only. Do not defeat the safety purpose of the polarized or grounding-type plug. A polarized plug has two blades with one wider than the other. A grounding type plug has two blades and a third grounding prong. The wide blade or the third prong is provided for your safety. If the provided plug does not fit into your outlet, consult an electrician for replacement of the obsolete outlet.

**WARNING**

The apparatus shall not be exposed to dripping or splashing and that no objects filled with liquids, such as vases, shall be placed on the apparatus.

**WARNING**

To reduce the risk of burns, fire, electric shock, or injury to persons:

- Unplug from outlet before putting on or taking off parts.
- Close supervision is necessary when this device is used by, or near children, invalids, or disabled persons.
- Use this device only for its intended use as described in these instructions. Do not use attachments not recommended by the manufacturer.
- Never operate the device if it has a damaged cord or plug, if it is not working properly, if it has been dropped or damaged, or dropped into water. Return the device to a service center for examination and repair.
- Protect the power cord from being walked on or pinched particularly at plugs, convenience receptacles, and the point where they exit from the apparatus.
- Keep the cord away from heated surfaces.
- Never drop or insert any object into any opening.
- Do not use outdoors.
- Do not operate where aerosol (spray) products are being used or where oxygen is being administered.
- To disconnect, turn all controls to the off position, then remove plug from outlet.

**CAUTION**

All electrical installation must be done according to national and local electrical code.

**Safety Instructions:** Rack Mount

**Elevated Operating Ambient:** If installed in a closed or multi-unit rack assembly, the operating ambient temperature of the rack environment may be greater than room ambient. Therefore, consideration should be given to installing the equipment in an environment compatible with the maximum ambient temperature (T<sub>ma</sub>) specified by the manufacturer.

**Reduced Air Flow:** Installation of the equipment in a rack should be such that the amount of air flow required for safe operation of the equipment is not compromised.

**Mechanical Loading:** Mounting of the equipment in the rack should be such that a hazardous condition is not achieved due to uneven mechanical loading.

**Circuit Overloading:** Consideration should be given to the connection of the equipment to the supply circuit and the effect that overloading of the circuit might have on overcurrent protection and supply wiring. Appropriate consideration of equipment nameplate ratings should be used when addressing this concern.

**Reliable Earthing:** Reliable earthing of rack-mounting equipment should be maintained. Particular attention should be given to supply connections other than direct connections to the branch circuit (e.g. use of power strips).

**Disconnect Device (Pluggable Equipment):** The socket-outlet shall be installed near the equipment and shall be easily accessible.

When using electrical products, basic precautions should always be followed, including the following:

- Read and follow all instructions before using.
- There are no user-serviceable components within this device. Removal of the cover from this device may present a shock hazard, and void the warranty.
- The mains plug is used as your disconnect device. This device shall remain readily operable.
- Unplug this apparatus during lightning storms or when unused for long periods of time.
- Do not overload the wall outlet where this device is being connected. Do not overload this device. Ensure the total load to this device does not exceed that which is listed in the specifications section of this manual.
- Ensure this device is connected to a properly grounded AC power source. Ensure the device is plugged into a source providing the required 120V. Do not use a plug adapter that defeats the ground pin of the AC plug.

## INSTRUCTIONS IMPORTANTES SUR LA SÉCURITÉ - FR

CONSERVER CES INSTRUCTIONS - Ce manuel contient des instructions importantes qui doivent être suivies lors de l'installation et de la maintenance de l'onduleur et des batteries.

- Utiliser uniquement les accessoires spécifiés par le fabricant.
- Lisez toutes les instructions avant d'utiliser le produit.

### Comprendre Les Symboles De Sécurité



#### **DANGER TENSION DANGEREUSE**

Le symbole de la pointe de flèche, dans un triangle équilatéral, est destiné à alerter l'utilisateur sur la présence de tension dangereuse non isolée dans l'enceinte du produit qui peut être d'une ampleur suffisante pour constituer un risque d'électrocution.



#### **AVERTISSEMENT**

Un avertissement vous avertit d'une situation pouvant entraîner des blessures graves ou la mort.



#### **ATTENTION**

Une attention vous avertit d'une situation pouvant entraîner des blessures mineures ou des dommages au produit et/ou à la propriété.



#### **REMARQUE**

Une remarque est utilisée pour mettre en évidence les procédures relatives à l'installation, au fonctionnement ou à l'entretien du produit.

**RAPPEL**

Un rappel indique quelles informations peuvent être importantes pour vous pour le contexte et/ou l'utilisation ultérieure.

**CONSEIL**

Un conseil aide les utilisateurs à appliquer des techniques et des procédures pour leurs besoins spécifiques. Les informations suggèrent des méthodes alternatives qui peuvent ne pas être évidentes et aider les utilisateurs à comprendre les avantages et les capacités du produit. Une astuce n'est pas essentielle à la compréhension de base du matériel.

**DANGER  
TENSION  
DANGEREUSE**

Pour réduire le risque de choc électrique: Toujours débrancher le meuble de la prise électrique avant de le nettoyer.

**AVERTISSEMENT**

Ne pas lire, comprendre et suivre les informations suivantes peut entraîner des blessures graves, des dommages à l'équipement ou de la nullité de la garantie. Il incombe à l'installateur/utilisateur de s'assurer que ce produit est chargé conformément aux spécifications.

**AVERTISSEMENT**

Risque de choc électrique: Brancher le meuble uniquement à une prise correctement mise à la terre. Ne pas détériorer le dispositif de sécurité de la fiche polarisée ou de la fiche de terre. Une fiche polarisée possède deux broches, dont l'une plus large que l'autre. Une fiche de type terre possède deux broches et une troisième de mise à la terre. La broche large ou la troisième fiche sont fournies pour des raisons de sécurité. Si la fiche fournie n'entre pas dans votre prise de courant, veuillez faire appel à un électricien pour remplacer la prise obsolète.

**AVERTISSEMENT**

L'appareil ne doit pas être exposé à des éclaboussures et aucun objet rempli de liquide, comme des vases, ne doit être placé sur l'appareil.

**AVERTISSEMENT**

Pour réduire les risques de brûlures, d'incendie, de choc électrique ou de blessures:

- Débrancher de la prise électrique avant d'installer ou de retirer des pièces.
- Surveiller étroitement ce meuble s'il est utilisé par ou à proximité d'un enfant, d'une personne invalide ou handicapée.
- N'utiliser ce meuble que pour l'usage auquel il est destiné, tel que décrit dans la présente fiche d'instructions. Ne pas utiliser d'accessoires non recommandés par le fabricant.
- Ne jamais utiliser ce meuble si le cordon ou la prise est endommagé, s'il ne fonctionne pas correctement, s'il est tombé ou est endommagé, ou s'il est tombé dans l'eau. Renvoyer le meuble à un centre de service après-vente pour qu'il soit examiné et réparé.
- Le cordon d'alimentation doit être placé de manière à éviter qu'il soit piétiné ou pincé, notamment au niveau des prises, des réceptacles et à la sortie de l'appareil.
- Garder le cordon d'alimentation loin des surfaces chauffées.
- Ne jamais faire tomber ou introduire un objet dans une ouverture.
- Ne pas utiliser en extérieur.
- Ne pas utiliser dans des lieux où des produits aérosols sont utilisés ou à proximité d'une source d'oxygène.
- Pour débrancher, placer tous les boutons en position off, puis retirer la fiche de la prise électrique.

**ATTENTION**

Toute installation électrique doit être effectuée conformément aux codes électriques nationaux et locaux.

**Consignes de sécurité:** montage en rack

**Température de fonctionnement élevée:** Si installé dans un rack fermé ou à unités multiples, la température ambiante de fonctionnement de l'environnement du rack peut être supérieure à ambiante de la pièce. Par conséquent, il faudrait envisager d'installer l'équipement dans un environnement compatible avec la température ambiante maximale (T<sub>ma</sub>) spécifiée par le constructeur.

**Réduction Air accréditives:** Installation de l'équipement dans un rack doit être telle que la quantité de flux d'air nécessaire au bon fonctionnement de l'équipement ne soit pas compromise.

**Chargement mécanique:** Le montage de l'équipement dans le rack doit être telle qu'une condition dangereuse ne soit liée à un chargement mécanique irrégulier.

**Surcharge des circuits:** Il faudrait envisager à la connexion de l'équipement au circuit d'alimentation et l'effet que la surcharge du circuit pourrait avoir sur la protection contre les surintensités et le câblage d'alimentation. Examen approprié des équipements évaluations de la plaque signalétique doit être utilisée pour traiter de cette préoccupation.

**Mise à la terre fiable:** Fiable mise à la terre de l'équipement de montage en rack doit être maintenue. Une attention particulière devrait être accordée aux connexions d'alimentation autres que les connexions directes vers le circuit de dérivation (par exemple de l'utilisation de bandes de puissance).

**Appareil Disconnect (Équipement Pluggable):** La prise de courant doit être installée à proximité du matériel et doit être facilement accessible.



Lors de l'utilisation des produits électriques, des précautions de base doivent toujours être respectées, y compris les suivantes:

- Lire et suivre toutes les instructions avant l'utilisation du matériel.
- Les composants de cet appareil ne pas réparés par l'utilisateur. Le retrait du capot de cet appareil peut provoquer un choc électrique et annuler la garantie.
- La fiche secteur est utilisée comme sectionneur de courant. Ce dispositif doit rester en état de marche.
- Débrancher cet appareil pendant les orages ou s'il n'est pas utilisé pendant de longues périodes.
- Ne surchargez pas le réceptacle de mur ou le circuit qui fournit l'énergie à ce appareil. Ne pas surcharger cette appareil. S'assurer que la charge totale à cet appareil ne dépasse pas celle qui est répertoriée dans la section des spécifications de ce manuel.
- Assurez-vous cet appareil est connecté à une source d'alimentation C/A avec mise à la terre. Assurez-vous cet appareil est branché
- sur une source d'alimentation fournissant les nécessaires 120V. Ne pas utiliser un adaptateur qui contrecarre la broche de terre de la prise du cordon d'alimentation.

## Regulatory Compliance

### Federal Communications Commission (FCC) Statement



#### CAUTION

Any changes or modifications not expressly approved by the party responsible for compliance could void the user's authority to operate the equipment.



#### NOTE

This equipment has been tested and found to comply with the limits for a Class B digital device, pursuant to part 15 of the FCC Rules. These limits are designed to provide reasonable protection against harmful interference in a residential installation. This equipment generates, uses and can radiate radio frequency energy and, if not installed and used in accordance with the instructions, may cause harmful interference to radio communications. However, there is no guarantee that interference will not occur in a particular installation. If this equipment does cause harmful interference to radio or television reception, which can be determined by turning the equipment off and on, the user is encouraged to try to correct the interference by one or more of the following measures:

- Reorient or relocate the receiving antenna.
- Increase the separation between the equipment and receiver.
- Connect the equipment into an outlet on a circuit different from that to which the receiver is connected.
- Consult the dealer or an experienced radio/TV technician for help.

# Conformité Réglementaire

Déclaration de conformité de la Federal Communications Commission (FCC)



## ATTENTION

Les changements ou modifications non expressément approuvés par le fabricant peuvent annuler le droit de l'utilisateur à utiliser l'équipement.



## REMARQUE

Cet équipement a été testé et jugé conforme aux limites d'un dispositif numérique de classe B, conformément à la partie 15 des règles de la FCC. Ces limites sont conçues pour fournir une protection raisonnable contre les interférences nuisibles dans une installation résidentielle. Cet équipement génère, utilise et peut émettre de l'énergie radiofréquence et, si non installé et utilisé conformément aux instructions, peut provoquer des interférences dans les communications radio. Cependant, il n'y a aucune garantie que des interférences ne se produiront pas dans une installation particulière. Si cet équipement provoque des interférences nuisibles à la réception radio ou de télévision, ce qui peut être déterminé en allumant et éteignant l'équipement, l'utilisateur est encouragé à essayer de corriger l'interférence par une ou plusieurs des mesures suivantes:

- Réorienter ou déplacer l'antenne de réception.
- Augmenter La distance entre l'équipement et le récepteur.
- Brancher l'équipement dans une prise sur un circuit différent de celui sur lequel est branché le récepteur.
- Consulter le revendeur ou un technicien radio/TV expérimenté.

## Industry Canada (IC)

ICES-003 Class B Notice. This Class B digital apparatus complies with Canadian ICES-003.

## Industrie Canada (IC)

ICES-003 Avis NMB-003, Classe B. Cet appareil numérique de la classe B est conforme à la norme NMB-003 du Canada.

# Waste Electrical and Electronic Equipment (WEEE) Directive



Correct disposal of this product: This symbol indicates that this product must not be disposed of with household waste, according to the WEEE Directive (2012/19/EU) and your national law. This product should be taken to a collection center licensed for the recycling of waste electrical and electronic equipment (EEE). The mishandling of this type of waste could have a possible negative impact on the environment and human health due to potentially hazardous substances that are generally associated with EEE. At the same time, your cooperation in the correct disposal of this product will contribute to the efficient use of natural resources. For more information about where you can take your waste equipment for recycling, please contact your local city office or your household waste collection service.

## Directive sur les déchets d'équipements électriques et électroniques (WEEE)



Élimination correcte de ce produit: Ce symbole indique que ce produit ne doit pas être éliminé avec les ordures ménagères, conformément à la directive WEEE (2012/19/EU) et à votre législation nationale. Ce produit doit être déposé dans un centre de collecte agréé pour le recyclage des déchets d'équipements électriques et électroniques (EEE). La mauvaise manipulation de ce type de déchets pourrait avoir un impact négatif possible sur l'environnement et la santé humaine en raison de substances potentiellement dangereuses généralement associées aux EEE. Dans le même temps, votre coopération dans l'élimination correcte de ce produit contribuera à une utilisation efficace des ressources naturelles. Pour plus d'informations sur les lieux de recyclage de vos équipements usagés, veuillez contacter votre mairie ou votre service de collecte des ordures ménagères.

# Understanding General Symbols and Terms



**NOTE**

A note highlights procedures pertaining to the installation, operation, or maintenance of the product.



**REMINDER**

A reminder marks information which may be of importance to you for recalling in context and later use.



**TIP**

A tip helps users apply techniques and procedures for their specific needs. The information suggests alternative methods that may not be obvious and help users understand the benefits and capabilities of the product. A tip is not essential to the basic understanding of the material.

# Supplied Components and Hardware

After carefully opening all product packaging, identify the supplied components and hardware shown. If any pieces are missing or damaged, please report it immediately to Technical Support at [av.middleatlantic.techsupport@legrand.com](mailto:av.middleatlantic.techsupport@legrand.com) or (866) 977-3901. Keep the original packaging in a safe place for future use.



**NEXSYS Series Rackmount PDU Unit**  
(Rack Ears Pre-Installed)

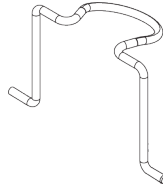

**Power Cord Retainer**



**Power Cord**  
(NEMA 5-15P or NEMA 5-20P SignalSAFE™ cord provided based on the model purchased.)

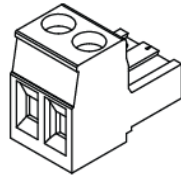

(2x)  
**Terminal Block Plug**  
(Pre-installed on PDU)



**User Manual**



**NOTE**

To order more hardware, contact support.

## Required Tools

- #2 Phillips Screwdriver



**WARNING**

Use tools with caution and follow all safety protocols.

**AVERTISSEMENT**

Utiliser des outils avec prudence et suivre tous les protocoles de sécurité.

# Introduction

This User Manual provides information about the installation, setup, and configuration of your NEXSYS Series Rackmount PDU product.

## Mounting Your NEXSYS Series Rackmount PDU

1. Use a #2 Phillips screwdriver and (4x) rack screws (not provided) through holes on the pre-installed ears and into the threaded holes on the rackrail to mount your NEXSYS Rackmount PDU as shown.

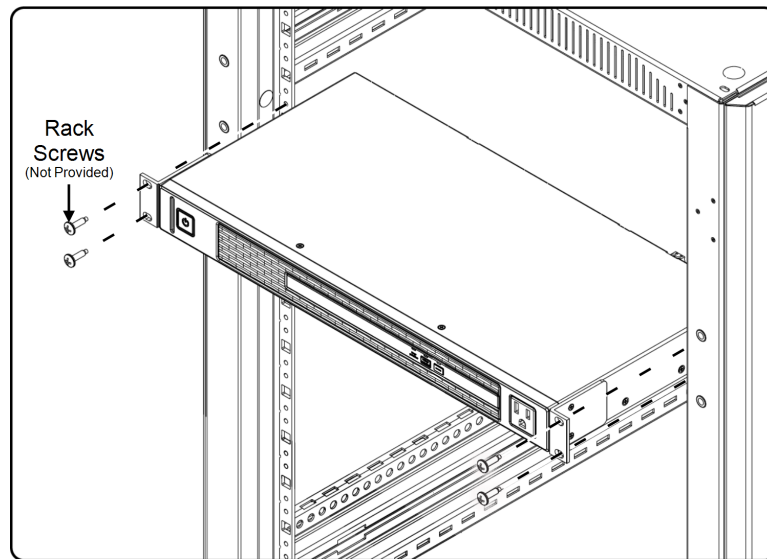
**NOTE**

The NEXSYS Rackmount PDU unit is 1 RU.

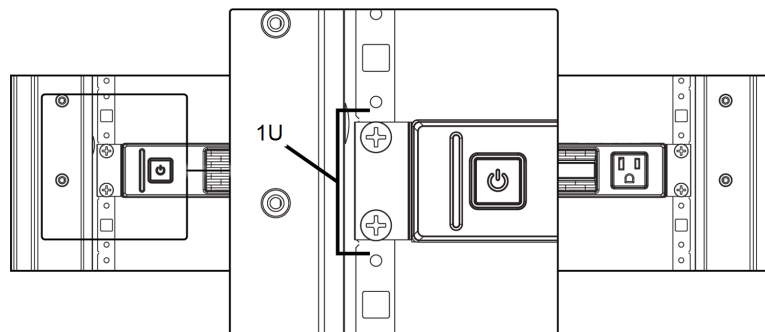

2. Install the power cord retainer (C) by pressing inward on its sides and hooking the ends through the input post holes on the back of the unit as shown.

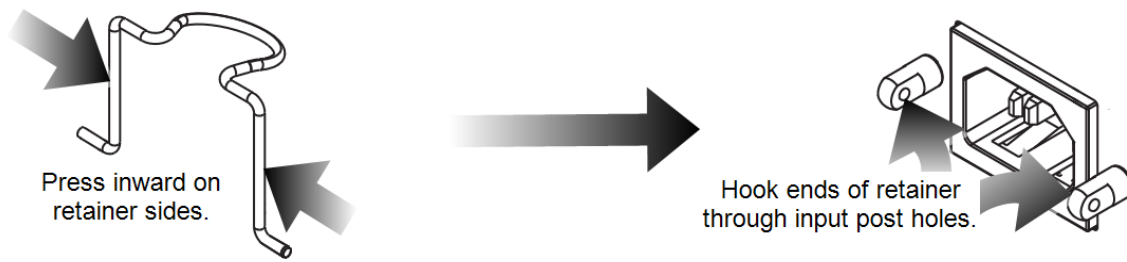

3. Use the power cord to connect your Rackmount PDU from the AC input into an outlet on an appropriately rated receptacle.

# Feature Set

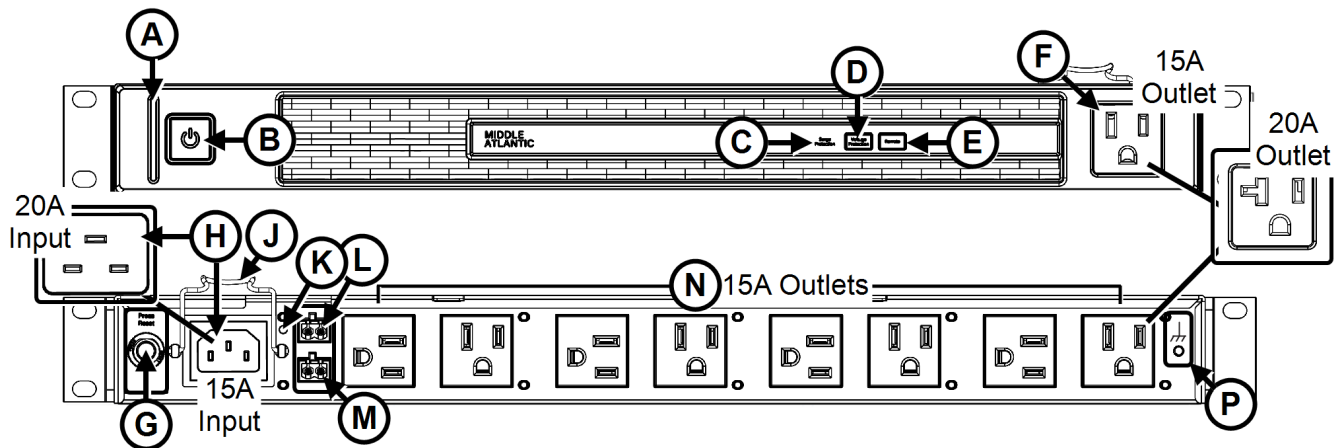

## A. Light Well

- White: On, indicating power to the outlets.
- Off: Off, no power to the outlets.

## B. Power Button

- White: On
- Amber: Off

## C. Surge LED Indicator

Surge indicator signals different protection statuses of your PDU. For more information, see [LED Protection Indicators](#), on page [18](#).

## D. Voltage Protection LED Indicator and Button

Voltage indicator signals different PDU protection statuses. For more information, see [LED Protection Indicators](#), on page [18](#).

Press to enable or disable voltage protection.

- White: Voltage protection enabled.
- Off: Voltage protection disabled.

## E. Remote LED Indicator and Button

Press to enable or disable remote contact control.

- White: Remote Enabled
- Off: Remote Disabled

## F. Convenience Outlet



Additional surge protected outlet on front of unit.

### G. Input Circuit Breaker

Located next to the AC input, the input circuit breaker trips when the load exceeds the PDU power rating.

### H. AC Input

IEC14 (for 15A) or IEC20 (for 20A) inlet based on the model purchased.

### J. AC Input Retainer Clip

Use clip to secure the power cord into the IEC Inlet.

### K. Indicator Light

Green LED indicates power to the outlets.

### L. Status (Output)

**NOTE**

Terminal Block plug pre-installed on PDU.

- For MOV Models: When contact is open, indicates the surge status is protected. When contact is closed, indicates the surge is compromised and no longer protected.
- For Series Protection Models: When contact is open, indicates the unit is powered Off. When the contact is closed, indicates the unit is powered on.

### M. Remote (Input)

**NOTE**

Terminal Block plug with jumper pre-installed on PDU.

When enabled, outlets may be turned On or Off via contact closure.

- When contact is closed, the outlets are turned On.
- When contact is opened, the outlets are turned Off.

### N. Outlets



All outlets controllable by power button and remote contact.

### P. External Grounding and Bonding Stud

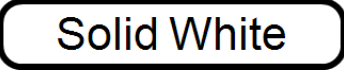

For connecting an external ground wire to bond the chassis.

# LED Protection Indicators

## Surge Protection

LED State	Description
	Protected. Normal state.
	First stage failed.
	Not protected.

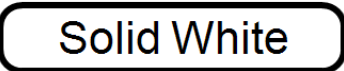
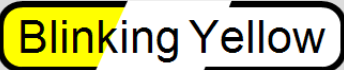
## Voltage Protection

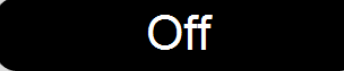
LED State	Description
	Voltage protection enabled.
	Under voltage.
	Over voltage.
	Voltage protection is off.

# Specifications

## Specifications for MOV Surge Models

### Summary

Model	PDX-915R	PDX-920R
Nominal Voltage	120VAC	
Voltage Range	Minimum: 80VAC, Maximum: 140VAC	
Frequency	60 Hz	
Maximum Peak Load	15A	20A
Rated Load	12A	16A
Number of Outlets	9	
Outlet Type	NEMA 5-15R	NEMA 5-20R
Overload Protection	Circuit Breaker	
Outlet Control	Contact Closure	
No Load Power Dissipation	< 1W	
Input Power Cord	SignalSAFE IEC to 5-15P, 10' (3M)	SignalSAFE IEC to 5-20P, 10' (3M)
Certifications	UL 62368, UL 1449, FCC Class B, ICES 7	

### Hardware Features

Model	PDX-915R and PDX-920R
Surge Protection	Multi-Stage MOV
Peak Impulse Current (8/20µS Waveform)	45,000 Amps, one time - Maximum peak impulse current pulse as defined between line and neutral. 19,500 Amps, two times within 5 minutes - Maximum multiple impulse current derated per spec.
Protection Mode	Line to Neutral only; no ground contamination.

<b>Model</b>	<b>PDX-915R and PDX-920R</b>
Response Time	Less than 1 nanosecond.
Surge Energy Dissipation	705 Joules (10/100 $\mu$ S)
Voltage Protection Rating	500V (L-N); Type 3 SPD
EMI/RF Suppression	>20dB Calculated Line to Neutral - 100kHz to 1Mhz - based on nominal impedance.
Overvoltage Threshold	Upper Limit Cutoff: 135V RMS Upper Limit Restore: 126V RMS
Undervoltage Threshold	Lower Limit Cutoff: 100V RMS Lower Limit Restore: 105V RMS

## Physical

Model	PDX-915R	PDX-920R
Dimensions (Width x Height x Depth)	19" (483mm) x 1.735" (44mm) x 8.75" (222mm)	
Product Weight	6.84 lbs (3.1 kg)	
Shipping Weight	9.92 lb (4.5 kg)	10.58 lb (4.8 kg)

## Warranty

Model	PDX-915R and PDX-920R
Power Distribution	Three Years Limited For warranty information, refer to <a href="http://www.legrandav.com/policies/warranty_information">www.legrandav.com/policies/warranty_information</a> .

## Specifications for Series Surge Protection Models

### Summary

Model	PDX-915R-SP	PDX-920R-SP
Nominal Voltage	120VAC	
Voltage Range	Minimum: 80VAC, Maximum: 140VAC	
Frequency	60 Hz	
Maximum Peak Load	15A	20A
Rated Load	12A	16A
Number of Outlets	9	
Outlet Type	NEMA 5-15R	NEMA 5-20R
Overload Protection	Circuit Breaker	
Outlet Control	Contact Closure	

Model	PDX-915R-SP	PDX-920R-SP
No Load Power Dissipation	<1W	
Input Power Cord	SignalSAFE IEC to 5-15P, 10' (3M)	SignalSAFE IEC to 5-20P, 10' (3M)
Certifications	UL 62368, UL 1283, UL 1449, FCC Class B, ICES 7	

## Hardware Features

Model	PDX-915R-SP	PDX-920R-SP
Surge Protection	Series	
Voltage Protection Rating	330V (L-N); Type 3 SPD	
Maximum Applied Surge Voltage	6000 Volts (1.2 x 50µS Pulse, Industry Standard Combination Wave Per IEEE C62.41)	
Maximum Applied Surge Current	Unlimited (Due to Inherent Current Limiting)	
Maximum Applied Surge Energy	Unlimited (Due to Inherent Current Limiting)	
EMI Filter, Differential Mode	40dB@100kHz	50dB@100kHz
50Ω Load	50dB@3MHz	50dB@30MHz
EMI Filter, Common Mode	18dB@100kHz	30dB@100kHz
50Ω Load	50dB@3MHz	50dB@30MHz
Overvoltage Threshold	Upper Limit Cutoff: 135V RMS Upper Limit Restore: 126V RMS	
Undervoltage Threshold	Lower Limit Cutoff: 100V RMS Lower Limit Restore: 105V RMS	

## Physical

Model	PDX-915R-SP	PDX-920R-SP
Dimensions (Width x Height x Depth)	19" (483mm) x 1.735" (44mm) x 8.75" (222mm)	
Product Weight	8.6 lb. (3.9 kg)	
Shipping Weight	11.47 lb. (5.2 kg)	12.35 lb. (5.6 kg)

## Warranty

Model	PDX-915R-SP and PDX-920R-SP
Series Surge Module	<p>Twelve Years Limited</p> <p>For warranty information, refer to <a href="http://www.legrandav.com/policies/warranty_information">www.legrandav.com/policies/warranty_information</a>.</p>

# Warranty

For warranty information, refer to [www.legrandav.com/policies/warranty\\_information](http://www.legrandav.com/policies/warranty_information).

## Contacting Corporate Headquarters

P: (866) 977-3901 | F: (877) 894-6918 | [www.legrandav.com](http://www.legrandav.com) | [av.middleatlantic.techsupport@legrand.com](mailto:av.middleatlantic.techsupport@legrand.com)

## Contacting Middle Atlantic Canada

P: (888) 766-9770 | F: (888) 599-5009 | [www.legrandav.com](http://www.legrandav.com) | [av.canada.customerservice@legrand.com](mailto:av.canada.customerservice@legrand.com)

### United States (US)

Legrand | AV Headquarters  
6436 City West Parkway  
Eden Prairie, MN, 55344, USA

At Legrand AV Inc. we are always listening. Your comments are welcome.

Legrand AV is an ISO 9001 and ISO 14001 Registered Company.